

RETEVIS

Ailunce

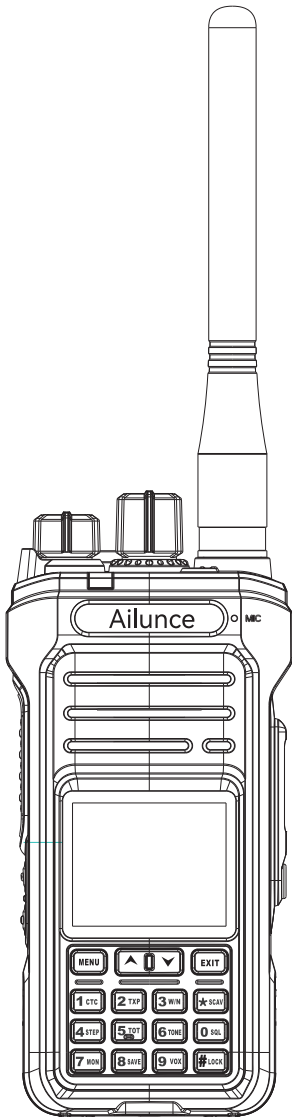

Ailunce HA1G

Two Way Radio

User's Manual

CONTENT

Important Attentions	01
Content	01
Overview	01
What's in the Box?	01
Battery Attentions	01
Feature Summary	03
Familiar with Radio	04
Menu Operations	05
DETAILED FUNCTION DESCRIPTIONS	09
GMRS Frequency Table	11
Specifications List as follows	11
Troubleshooting	12
WARNINGS	13
GUARANTEE	17

For downloading further resources:
Brochures, Software/Firmware, Manual etc, Please contact
your direct reseller first OR go to website retevis.com and
check “support” in the each product link to download it.

Important Attentions

Before using the Ailunce HA1G, please read the manual which contains important operating instructions for safe usage, RF Energy Awareness, control information, and operational instructions for compliance with RF Energy Exposure limits in applicable national and international standards.

Overview

HA1G is the first GMRS radio of Ailunce brand, and is designed for GMRS radio fans. Ailunce HA1G IP67 waterproof GMRS two way radio with dual band scanning receiver (UHF/VHF), GMRS repeater capable, Type-C charging, 2800mAh long standby two way radio.

Unpacking and Checking Equipment

Please check the packing box of this product and see if there is any sign of damage.

Please open the packing box carefully, we recommend that you identify the items listed in the following packing list. If you find that our product and its accessories in hand are lost or damaged during the shipment, please immediately contact dealers.

What's in the Box?

This radio comes with the following items in the box:

Radio Body

2800mAh Lithium-Ion battery pack

TYPE-C USB Charging Cable

Belt clip

Charging Base

Power Adapter

User Manual

Battery Attentions

The battery is not completely charged at the factory, please charge it before using it. To extend the battery lifetime, please turn off the radio when you don't use it, and save it in a cool (temperature around 25 °C) and dry place.

Battery Attentions

Misuse of Li-ion batteries may result in the following hazards: smoke, fire, or the rupture of the battery. Misuse can also cause damage to the battery or degradation of the battery's performance.

- 1.NEVER use the incinerated battery packs. Internal battery gas may cause an explosion.
- 2.NEVER strike or use other ways to impact the battery pack. Do not use the battery pack if it has severely impacted or dropped, or subjected to heavy pressure. Battery pack damage may not be visible on the outside of the case. Even if the surface of the battery does not show cracks or any other damage, the cells inside the battery may rupture or fire.
- 3.DANGER! NEVER leave the battery pack in places with temperatures above 60°C (140°F). A high-temperature buildup in the battery cells may cause the battery cells to rupture or catch fire, such as near fires or stoves, inside a sun-heated vehicle, or in direct sunlight for long periods of time. Excessive temperatures may also degrade the pack's performance or shorten the battery cell's life.
- 4.NEVER place the battery packs near a fire. Fire or heat may cause them rupture or explode. Dispose of used battery packs in accordance with local regulations.
- 5.NEVER solder the battery terminals, or modify the battery pack. This may cause heat generation, and the battery may burst, emit smoke or fire.
- 6.NEVER let fluid from inside the battery get in your eyes. This can cause blindness. Rinse your eyes with cleanwater, without rubbing them, and immediately go to a doctor.
- 7.NEVER use the deteriorated battery packs, which could cause a fire.
- 8.NEVER let fluid from inside the battery cells come in contact with your body. If it does, immediately wash with clean water.
9. NEVER put the battery packs in a microwave oven, high-pressure container, or in an induction heating cooker. This could cause a fire, overheating, or cause the battery cells rupture.
- 10.CAUTION: DO NOT expose the battery packs to rain, snow, salt water, or any other liquids. Do not charge or use a wet battery pack. If the battery pack gets wet, be sure to wipe it dry cloth before using it.
- 11.DO NOT use the battery if it emits an abnormal odor, heats, or is discolored or deformed. If any of these conditions occurs, contact your Ailunce dealer or distributor.
- 12.DO NOT use the battery pack out of the specified temperature range -10°C ~ +45°C. Using the pack out of

this range will reduce the battery pack's performance and affect the battery cell life.

13. DO NOT leave the battery pack fully charged, completely discharged, or in an excessive temperature environment (above 50°C, 122°F) for an extended period of time. Otherwise, the service life of the battery will be reduced. If the battery pack is left unused for a long time, it must be detached from the transceiver after discharging.

Charging Attentions

1. DANGER! NEVER charge the battery pack in areas with extremely high temperatures, such as near fires or stoves, inside a sun-heated vehicle, or in direct sunlight. In such environments, the safety/protection circuit in the battery pack will be activated and the charging will be stopped.
2. NEVER charge the transceiver during a lightning storm. It may result in an electric shock, a fire, or damage to the transceiver. Disconnect the power adapter before a storm.
3. NEVER charge or leave the battery in the battery charger beyond 8 hours for charging. If the battery pack is not completely charged during the specified time, stop charging and remove it from the battery charger. Continuing to charge the battery pack beyond the specified time limit may cause a fire, overheats, or the battery may rupture.
4. Occasionally observe the battery pack condition while charging. If any abnormal condition occurs, stop using the battery pack.
5. DO NOT insert the transceiver with the battery pack attached to the charger if it is wet or soiled. This could corrode the battery charger terminal or damage the charger. The charger is not waterproof.
6. DO NOT charge the battery pack out of the specified temperature range: 10°C ~ 40°C (32°F ~ 104°F). Ailunce recommends charging the pack at 25°C (77°F). The battery pack may overheat or rupture if charged out of the specified temperature range. Additionally, the battery performance or the battery life may be reduced.

Charging Operations

1. Insert the power adapter into the power supply socket.
2. Insert the output terminal of the power adapter into the DC jack behind the charging kit.
3. Insert the battery or radio equipped with the battery into the charging kit.
4. Confirm the battery and charging kit terminal contact reliably, when the charging indicator turns red and charging starts.
5. After completing charging (charging about 7 hours), the indicator turns green.

Attachment Installment

1. Install the Battery

Match the grooves of the battery pack with the corresponding guides on the back of the transceiver, and then push it. Press the battery and radio firmly together until the release latch on the top of the radio locks. After hearing a "click" sound, the battery was locked. To remove the battery, make sure the radio has been turned off, then slide up the release latch and remove the pack away from the radio.

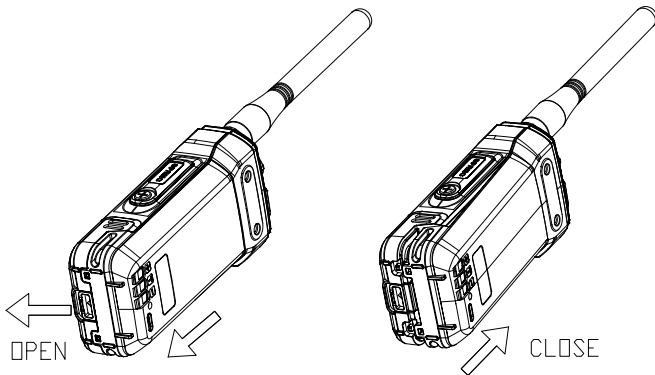

2.Install / Uninstall the Belt Clip

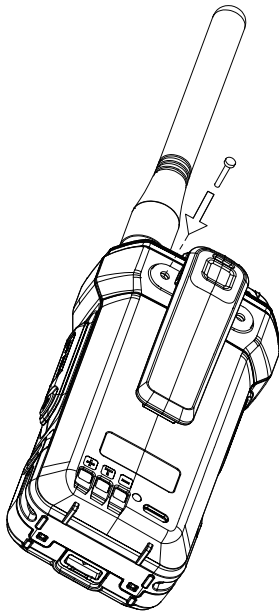

Place the belt clip to the corresponding grooves on the back of the radio, and then screw it if need. Anticlockwise turn screws to remove the belt clip.

Feature Summary

- 30 GMRS Channels
- Up to 250 Custom Channels
- 136-174 MHz/400-480 MHz Receive Only
- NOAA weather Channels
- NOAA weather alerts
- FM Radio
- Standard CTCSS/DCS Tones
- Support Splitting CTCSS/DCS Tone
- Selectable High/Low TX Power
- Channel Scan/Priority Scan
- Selectable Wide/Narrow Bandwidth
- 1.77 Color Backlight LCD Dual Display
- Channel Name, Number or Frequency Display
- Backlight Keypad
- Busy Channel Lockout
- Low Battery Alert
- 2 Programmable Function Keys
- IP67 Waterproof
- 2800mAhType-C Charging battery

Familiar with Radio

1.Parts of the radio

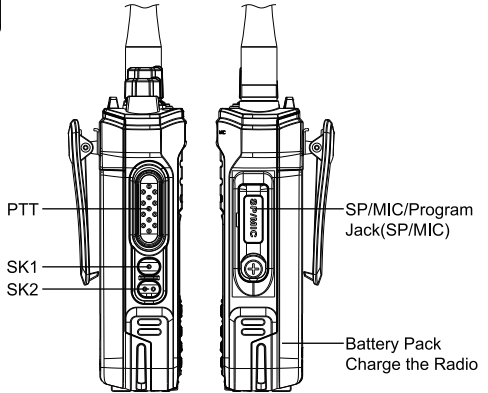
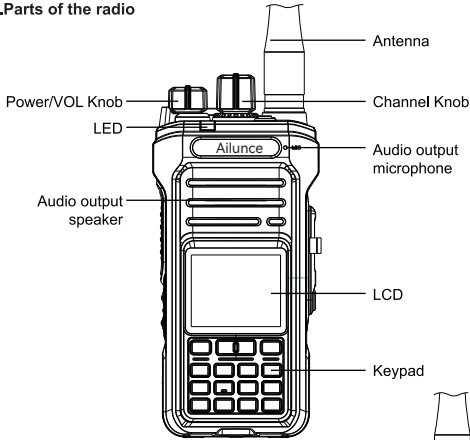

2.Menu Icon Display

- 1.Signal bar;
- 2.Speaker
- 3.Lock
- 4.Earpiece
- 5.Scan
- 6.Monitor
- 7.Emergency
- 8.FM broadcast radio
- 9.NOAA
- 10.Charging
- 11.battery indicator
- 12.channel number in the zone
- 13.zone number
- 14.Frequency, CH number, CH name display;
- 15.CH number
- 16.VOX on
- 17.TA/Fl: Talk around/ Reverse frequency CTCSS Tone Type
- TX Power
- Shift Direction +/-
- Bandwidth

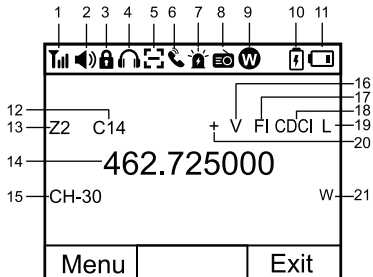

3. Custom Side-Key Function

You can custom set below functions on the radio: High/Low power, turn on/off scan, FM radio, VOX, Zone +/-, Sub PTT;

4. Key Function Instruction

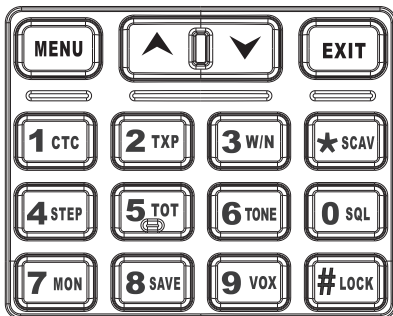

Menu	Menu/ Confirm button
Exit	Exit menu; Long press [Exit] switch MR/VFO mode.
Up/Down	up/down through channels and menu settings; When scanning change the scan direction.
[*scan]	Long press start scan; short press switch Band A/B;
[0SQL]	Quickly enter squelch level setting.
[#Lock]	Short press to switch Single/Dual band. Long press the key lock and unlock.

Menu Operations

Radio Setting

1. Display Mode

You can choose to display channel frequency, channel name or CH number.

- (1) Press the MENU key to enter the setting interface.
- (2) Press the UP key or DOWN key to choose: frequency, name or channel.
- (3) Press the MENU key to save and exit.

2. Band Setting

Here choose displays, single band or dual band.

- (1) Press Menu to enter Band Set.
- (2) Up and Down keys to choose Band A or Band B.
- (3) If stop at Band A, press the menu Key to choose and cancel this choice.

3. Backlight Setting

Set the backlight brightness and backlight time. The backlight time is set in steps of 5S, and the maximum backlight time is 1 hour. If the backlight time is 0, the backlight is always on.

- (1) Switch channel knob to adjust the brightness level. Counterclockwise turn the channel knob to darken the screen, clockwise will bright the screen.
- (2) Press up and down key to adjust the bright time.

4. Key Function

- (1) Key Lock mode. Choose Auto or manually to lock the radio.
- (2) Key Lock Setting. In order to prevent accidental frequency change or inadvertent transmission. Various aspects of the radio's keys and switches may be locked out. You can choose to lock keyboard, channel knob, or side-key, or to lock all of them.

(3)Key Function

Long/Short custom side-key function of the TK key, SK1, SK2.

Selective custom function is totally 13: power switch, squelch, monitor, scan, zone+/-, FM radio, talk around, reverse frequency, turn on/off emergency alarm, programmable PTT, optional signaling code.

Up and down key to choose the custom function, press Menu key to select the function.

5.Audio

(1)Audio Enable.

Here choose Transmit permit tone, key beep and Voice broadcast. Up and down key to choose tones, press Menu to confirm. If voice broadcast is enabled, and the radio is low power, it will broadcast "Low voltage".

(2)Mic Gain.

Press menu to enter mic gain setting, up and down key to choose Normal, Strengthen, and low mic gain.

6.VOX

The VOX function provides automatic transmit/receive switching based on voice input to the microphone. With the VOX switch ON, you do not need to press the PTT switch in order to transmit.

(1)Turn the channel knob to adjust the VOX thresh level 1-15.

(2)Up or down key to VOX delay time setting.(3)Key Function

Long/Short custom side-key function of the TK key, SK1, SK2.

Selective custom function is totally 13: power switch, squelch, monitor, scan, zone+/-, FM radio, talk around, reverse frequency, turn on/off emergency alarm, programmable PTT, optional signaling code.

Up and down key to choose the custom function, press Menu key to select the function.

5.Audio

(1)Audio Enable.

Here choose Transmit permit tone, key beep and Voice broadcast. Up and down key to choose tones, press Menu to confirm. If voice broadcast is enabled, and the radio is low power, it will broadcast "Low voltage".

(2)Mic Gain.

Press menu to enter mic gain setting, up and down key to choose Normal, Strengthen, and low mic gain.

6.VOX

The VOX function provides automatic transmit/receive switching based on voice input to the microphone. With the VOX switch ON, you do not need to press the PTT switch in order to transmit.

(1)Turn the channel knob to adjust the VOX thresh level 1-15.

(2)Up or down key to VOX delay time setting.

Zone Setting

This radio supports 16 zones, and every 16 channels in a zone. Default display 2 zones and all channels options.

(1)All channels means it will list all the channels you create on this radio.

(2)Zone-1 including channel 1 to 16. Zone-2 default including channel 17-30.

(3)Up and down key to choose display all channels, or zone-1, and zone-2.

(4)Press menu to select this zone or edit the channels in the zone.

(5)Press menu again to confirm the choice.

Channel setting

Default set 2 VFO receiving channels and 30 GMRS channels. Up and down key to choose the destination channel, then you can set the channel details.

(1)Channel Alias.

① Name the channel via below keyboard setting,

for example, press 【2TXP】 key more times to choose 2, A, B,C a, b, c; press menu key to save the channel name and When the cursor moves to the last character, press [EXIT] to delete the characters.

1 Punctuation	2 ABC	3 DEF
4 GHI	5 JKL	6 MNO
7 PQRS	8 TUV	9 WXYZ

(2)Bandwidth

You can choose the bandwidth for the current channel, default Wide for channel 1-7 and 15-30 GMRS channels, and you can change to bandwidth for these channels. Default unchangeable Narrow for 8-14 GMRS channels.

(3)RX Frequency.

The frequency range can be input: 136-174MHz and 400-480MHz,

If out of range, the radio will automatically back to the default GMRS channel frequency.

(4)TX frequency. Same operation of RX frequency. But it will prohibit transmitting on frequency out of range GMRS frequency.

(5)CTCSS/CDC: Receiving and transmitting CTCSS/DCS set respectively.

① Up and down key to choose set RX or TX CTCSS CTCSS/DCS.

② Short press [#lock] to quickly choose the CTCSS/DCS types.

③ Switch the channel knob to adjust the CTCSS/DCS values.

Below are the CTCSS/DCS tones table.

CTCSS TONE FREQUENCY (Hz)						
67.0	69.3	71.9	74.4	77.0	79.7	
82.5	85.4	88.5	91.5	94.8	97.4	
100.0	103.5	107.2	110.9	114.8	118.8	
123.0	127.3	131.8	136.5	141.3	146.2	
151.4	156.7	159.8	162.2	165.5	167.9	
189.9	192.8	196.6	199.5	203.5	206.5	
210.7	218.1	225.7	229.1	233.6	241.8	
250.3	254.1					

CTCSS TONE FREQUENCY (Hz)						
023	074	172	265	371	503	662
025	114	174	266	411	506	664
026	115	205	271	412	516	703
031	116	212	274	413	523	712
032	122	223	306	423	526	723
036	125	225	311	431	532	731
043	131	226	315	432	546	732
047	132	243	325	445	565	734
050	134	244	331	446	606	743
051	143	245	332	452	612	754
053	145	246	343	454	624	
054	152	251	346	455	627	
065	155	252	351	462	631	
071	156	255	356	464	632	
072	162	261	364	465	645	
073	165	263	365	466	654	

(6)Squelch level.

The Squelch system allows you to mute the background noise when no signal is being received. Not only does the Squelch system's "standby" operation more pleasant, but it also significantly reduces battery current consumption.

Press menu key to enter the Squelch setting, rotate the channel knob to set the squelch level. Default is 5.

(7)TX Power.

Set current channel transmit power, default high power for channel 1-7 and 15-30, default low power for channel 8-14.

(8)TX Permission Set

Set the transmit permission and transmit time and timer.

In this menu, rotate the channel knob to adjust the TOT time.

Press up and down key to choose the transmit permission options: CTC/CDC Match,Channel free,Receive only,Always allow.

(9) Signaling System

Choose a signaling list for the current channel. The content of the signaling list can be set in the signaling menu.

(10) Scan List

Choose a scan list for this current channel. Set the scan list in the scan menu.

(11) Emergency List

Choose an emergency list for the current channel. Set the emergency list in the Emergency menu.

(12) Talk around

Enable this feature to Talk-ground the repeater frequency.

(13) VOX Enable

Enable VOX function for the current channel. Press menu to select the VOX, and then confirm.

Scan setting

Press menu key enter the scan setting menu.

- ① Scan list Alias. When the cursor is behind a character, press [EXIT] to delete the character.
- ② Scan Condition. Select the scan condition carrier or CTCSS/DCS match.
- ③ Scan mode. Select the scan mode: Carrier, Time, Search.
- ④ TX Mode set: Choose Selected, Last Active channel, Designated Channel.
- ⑤ Designated Channel Select: if scan a signal, it will transmit from this design channel.
- ⑥ Priority Channel 1: Choose a priority scan channel.
- ⑦ Priority channel 2: choose the second priority scan channel.
- ⑧ Channel List: Add the scanned channels in the list, then it will scan according to these channels.
- ⑨ Hang time: Set the hang time if the scan carrier disappear. Rotate the channel knob to adjust the time.

Signaling

1) Common Setting.

PTT ID setting.

- ① Up and down key to set the PTT ID type, Side tone, BOT and EOT.
- ② Type: Rotate the channel knob to choose PTT ID types: All, BOT, EOT; Rotate the channel knob to choose one of the types.
- ③ BOT and EOT: means transmit the PTT ID begin of the transmit or end of the transmit. Edit the PTT ID via number keys.

Decode Setting

- ① Up and down key to choose set Disable ID, Revive ID, Call ID, Stun type, Show ANI.
- ② Edit the decode ID via number keys.

The character range is: [0, 1, 2, 3, 4, 5, 6, 7, 8, 9, A, B, C, D, *, #]

2) DTMF Signal

DTMF system:

- ① System Alias.

Same operation with the channel Alias. When the cursor is behind a character, press [EXIT] to delete the character.

- ② "DTMF Signaling", default code squelch.
 - ③ DTMF Group Code. Rotate the channel Knob to select the group code (OFF, A, B, C, D, *, #)
 - ④ DTMF code length. Rotate the channel Knob to set the code time length.
 - ⑤ Fast Call Lists. DTMF signaling code in the list can be transmitted directly. Here need to set the fast call list in the CPS.
 - ⑥ Encode & Decode
- Encode and Decode Enabled options. Press **[MENU]** to choose or cancel encode or decode.
- ⑦ Default 4 DTMF systems list on the radio.

Emergency

- ① Emergency System Alias

Named emergency system same operation with the channel Alias. When the cursor is behind a character, press [EXIT] to delete the character.

- ② Alarm Type. choose the emergency call type:

Siren Only: Only alarm sound, will not transmit.

Regular: The radio transmits an alarm signal and provides audio that it is in Emergency mode.

Silent: The radio transmits an alarm signal but gives no audio.

Silent w/Voice: The radio transmits an alarm signal but gives no audio that it is in Emergency mode.

Up and down key to choose the emergency type, Menu key to confirm.

③ Alarm Mode

Emergency alarm: After the emergency alarm is activated, the radio only provides the alarm sound.

Emergency with call: no alarm tone will be sent, and the MIC will be turned on to transmit.

Emergency Alarm w/call: After the alarm is activated, the host will send an emergency call with an emergency alarm sound.

Up and Down key to choose the emergency modes.Menu key to confirm.

④ Alarm Revert Channel: Choose the channel to transmit the emergency call.

⑤ Attribute Setting: default local alarm enabled.

Call Tone

There have 10 call tones to choose. When in standby, long press [6TONE] to send a automatically call to the receiver.

Weather Setting

1.Weather Alarm. Press [MENU] to enter the menu to turn on or off Weather Alarm.

2.NOAA Channel List. Up and down to choose the NOAA channel, and press [MENU] to confirm select this channel, and check the NOAA channel info.

FM Radio

The receiving frequency range of the FM radio is 76~108 MHz.

Shortly press the Up key or Down key to increase the receiving frequency by 2MHz.Rotate the Channel knob to increase the receiving frequency by 0.1MHz.

Long press the Up key or Down key to search channels automatically, after finding the channel, it will automatically switch to the receiving frequency.

Factory Reset

A factory data reset erases your data from the radio.

Press [MENU] enter the main menu, and then up and down key to Factory Reset Menu. Press [MENU] three times confirm to do factory reset.

DETAILED FUNCTION DESCRIPTIONS

1.Power On Password setting.

Set the power on or read/write a password via CPS.

If forget the password, please contact the dealer to reset the data.

2.Channel and Zone

This GMRS radio supports to create 256 channels and supports 16 zones, 16 channels per zone. Also, there is a "All Channel" . If you choose "All channel" the radio will display all the channels you create. Default is All Channel.

3.Scan Function Use

First make sure that there is at least one scan list, if not, create one on the CPS software.

① According to the scan list settings, set the scan condition, choose scan mode and Designed transmit channel.

② Create and save the channels in the scan list.

③ Go to Channel Setting> >Scan List>> choose a scan list for current channel.

④ Under CH mode, Long press [*SCAN] button will start scanning the channels in the current scan list. But firstly, these channels need to add this scan list in the channel setting.

⑤ Under VFO mode, long press [*scan] button will start scanning the frequency according to the frequency step. Press up and down key to change the scanning direction.

4.CTCSS/DCS scanning

Under the VFO and CH mode without a CTCSS tone, long press the [1CTC] button enter the RX CTCSS/DCS setting menu, short press [*scan] will begin scanning the transmitting radio CTCSS/DCS. Press [MENU] key to save the scanned receiving CTCSS/DCS.

5.Emergency system setting

① Enter the emergency system menu to set the emergency settings: emergency system name, emergency type,

emergency mode and transmit back channel.

② Go to channel setting menu >>Emergency List >> add current channel in a Emergency list. If no emergency list added in this channel, it will not transmits an alarm sound.

③ Go to menu Radio Setting>>Key Function>>Set a custom key to Emergency start or stop. Default TK Short press to start the emergency alarm, TK Long press to stop the emergency alarm.

6.VOX Function

① VOX function only works for the current channel.

② Go to menu Channel Setting>>VOX Enable>>Enable or disable the VOX for the current channel.

③ Go to menu Radio Setting>>VOX>>Thresh to set the VOX sensitivity level. Delay to set the VOX transmit delay time.

7.Dual Standby

① Short press [#LOCK] to switch single band or dual band.

② Radio Setting>>Band Setting>>Select Band A or Band B.

8. DTMF

1.DTMF decoding

① Press [MENU] to enter Signal Decode setting.

② Stun Type: If choose Stun Rx, means you allow others to disable your radio receiving with the Stun ID, and you can still transmit. If choose Stun TX/RX, means you allow others to disable your radio transmitting and receiving with the Stun ID, then you cant transmit and receive.

③ Revive ID: With this ID, you allow others to revive your radio after the radio is killed by others' radio.

Call ID: The radio identification code. The transmitter need to know this code and then transmit the DTMF signaling.

Show ANI: Rotate the channel knob to show the ANI ID or not.

2.DTMF encoding

① Press [MENU] to enter the DTMF System setting.

② Create the Fast Call List in the programming software.

	DTMF name	System1	DTMF Code Length	30ms
	DTMF Signaling	Code Squelch	Intermediate Code	0
	Group Code	None	Fast call 1	
	Fast call 2		Fast call 3	
	Fast call 4		Fast call 5	
	Fast call 6		Fast call 7	
	Fast call 8		Fast call 9	
	Fast call 10		Decode enable	<input type="checkbox"/>
	Encode enable	<input checked="" type="checkbox"/>		

③ Choose the fast call list, press [MENU] to call out the DTMF call.

3.PTT ID

① PTT ID is the function to transmit an identification code when making a call. A user can view the caller's ID with the received PTT ID if choose show ANI ID.

② PTT ID Type:

PTT ID Type	Description
Off	The PTT ID is not transmitted.
BOT	You can transmit the PTT ID when pressing the PTT begin of the transmit.
EOT	You can transmit the PTT ID when pressing the PTT end of the transmit.
Both	You can transmit the PTT ID when pressing/releasing the PTT.

GMRS Frequency Table

CH NO.	CH Name	RX Frequency	TX Frequency	Bandwidth	Power
1	GMRS-01	462.56250	462.56250	Wide	High/Low Optional
2	GMRS-02	462.58750	462.58750	Wide	High/Low Optional
3	GMRS-03	462.61250	462.61250	Wide	High/Low Optional
4	GMRS-04	462.63750	462.63750	Wide	High/Low Optional
5	GMRS-05	462.66250	462.66250	Wide	High/Low Optional
6	GMRS-06	462.68750	462.68750	Wide	High/Low Optional
7	GMRS-07	462.71250	462.71250	Wide	High/Low Optional
8	GMRS-08	467.56250	467.56250	Narrow	Low
9	GMRS-09	467.58750	467.58750	Narrow	Low
10	GMRS-10	467.61250	467.61250	Narrow	Low
11	GMRS-11	467.63750	467.63750	Narrow	Low
12	GMRS-12	467.66250	467.66250	Narrow	Low
13	GMRS-13	467.68750	467.68750	Narrow	Low
14	GMRS-14	467.71250	467.71250	Narrow	Low
15	GMRS-15	462.55000	462.55000	Wide	High/Low Optional
16	GMRS-16	462.57500	462.57500	Wide	High/Low Optional
17	GMRS-17	462.60000	462.60000	Wide	High/Low Optional
18	GMRS-18	462.62500	462.62500	Wide	High/Low Optional
19	GMRS-19	462.65000	462.65000	Wide	High/Low Optional
20	GMRS-20	462.67500	462.67500	Wide	High/Low Optional
21	GMRS-21	462.70000	462.70000	Wide	High/Low Optional
22	GMRS-22	462.72500	462.72500	Wide	High/Low Optional
23	RPT-01	462.55000	467.55000	Wide	High/Low Optional
24	RPT-02	462.57500	467.57500	Wide	High/Low Optional
25	RPT-03	462.60000	467.60000	Wide	High/Low Optional
26	RPT-04	462.62500	467.62500	Wide	High/Low Optional
27	RPT-05	462.65000	467.65000	Wide	High/Low Optional
28	RPT-06	462.67500	467.67500	Wide	High/Low Optional
29	RPT-07	462.70000	467.70000	Wide	High/Low Optional
30	RPT-08	462.72500	467.72500	Wide	High/Low Optional

Specifications List as follows:

General	
TX Frequency Range	462~467Mhz
Channel Capacity	250
Working Voltage	DC 7.4V
Working Temperature	-10 C ~+50 C
Battery Capacity	2800mAh
Antenna Impedance	50Ω
Channel Step Value	12.5KHz/25KHz;
Transmitter	
Output Power	≤5W
Adjacent Channel Power	Wide band : ≤-65dBc ; Narrowband : ≤-62dBc

CTCSS/CDCSS Modulation	Wide band : 0.75KHz±0.1KHz; Narrowband : 0.4KHz±0.1KHz;
Audio Distortion	≤5%
Modulation Sensitivity	8-12mV
Maximum Frequency Deviation	Wide-band: ≤5KHz ; Narrowband: ≤2.5KHz
Spurious Power	≤-20dBm;
Modulation Mode	Wide band : 16KφF3E; Narrowband: 11KφF3E
Transmit Current	≤1.70A
Pre-emphasis Character	6dB/every time the frequency will increase
Receiver	
Sensitivity	Wide band : -123dBm; Narrowband: -124dBm;
Voice Output Power	≥500mW
Audio Distortion	≤5%
Obstruct	≥85dB
Inter-modulation	Wide band : ≥65dBc; Narrowband: ≥60dBc
Adjacent Channel Selection	Wide band : ≥65dBc; Narrowband: ≥60dBc
Spurious Power	RX≤-57dBm
Spurious Rejection	≥65dBc
Receiving Current	≤400mA

Troubleshooting

The transceiver does not turn ON.	The battery is exhausted.	Charge the battery pack, or replace the batteries.
	Loose the connection of a battery pack (case).	Clean the battery terminals.
No sound comes from the speaker.	The volume level is too low.	Rotate Volume Knob to adjust the level.
	The squelch level is too high.	Adjust the squelch level.
	An external speaker is connected to the [SP] jack.	Check the external speaker connection.
	The CTCSS tone is not compatible.	Disable CTCSS/DCS or be sure setting matches incoming transmission.
Keypad is unresponsive	Keyboard locked or not.	Check if the keypad has been locked. Check if other keys are currently pressed.
Battery life lower than expected		Be sure the charger indicates the battery is fully charged. • The battery pack capacity will naturally diminish over a number of charge cycles. This is the case with all lithium batteries.
Transmitting is impossible.		Set the transmit power level to High.
	The PTT Lock function is activated.	Turn OFF the PTT Lock function on the MENU screen.
	The Busy Lockout function is activated.	Turn OFF the Busy Lockout function on the MENU screen.
	The transmit frequency is out of the amateur radio band.	Set the transmit frequency within the amateur radio band.

The list aims at helping you correct the problems that don't belong to the device's fault. If you can't find out the reason for problems or can't work them out, please contact your seller or customer service. As follow email address:hams@ailunce.com.

RF ENERGY EXPOSURE AND PRODUCT SAFETY GUIDE FOR TWO-WAY RADIOS



ATTENTION!

Before using this radio, read this guide which contains important operating instructions for safe usage and rf energy awareness and control for compliance with applicable standards and regulations.

- User instructions should accompany the device when transferred to other users.
 - Do not use this device if the operational requirements described herein are not met.
- This two-way radio uses electromagnetic energy in the radio frequency (RF) spectrum to provide communications between two or more users over a distance. RF energy, which when used improperly, can cause biological damage.
- All Retevis two-way radios are designed, manufactured, and tested to ensure they meet government-established RF exposure levels. In addition, manufacturers also recommend specific operating instructions to users of two-way radios. These instructions are important because they inform users of RF energy exposure and provide simple procedures on how to control it.
- Please refer to the following websites for more information on what RF energy exposure is and how to control your exposure to assure compliance with established RF exposure limits: <http://www.who.int/en/>

When two-way radios are used as a consequence of employment, the Local Government Regulations requires users to be fully aware of and able to control their exposure to meet occupational requirements. Exposure awareness can be facilitated by the use of a product label directing users to specific user awareness information. Your Retevis two-way radio has a RF Exposure Product Label. Also, your Retevis user manual, or separate safety booklet includes information and operating instructions required to control your RF exposure and to satisfy compliance requirements.

Unauthorized modification and adjustment

Changes or modifications not expressly approved by the party responsible for compliance may void the user's authority granted by the local government radio management departments to operate this radio and should not be made. To comply with the corresponding requirements, transmitter adjustments should be made only by or under the supervision of a person certified as technically qualified to perform transmitter maintenance and repairs in the private land mobile and fixed services as certified by an organization representative of the user of those services.

Replacement of any transmitter component (crystal, semiconductor, etc.) not authorized by the local government radio management departments equipment authorization for this radio could violate the rules.

FCC Requirements:

This device complies with part 15 of the FCC Rules. Operation is subject to the condition that this device does not cause harmful interference. (Licensed radios are applicable);

This device complies with part 15 of the FCC Rules. Operation is subject to the following two conditions: (Other devices are applicable)

- (1) This device may not cause harmful interference, and
- (2) This device must accept any interference received, including interference that may cause undesired operation.



This equipment has been tested and found to comply with the limits for a Class B digital device, pursuant to part 15 of the FCC Rules. These limits are designed to provide reasonable protection against harmful interference in a residential installation. This equipment generates, uses and can radiate radio frequency energy and, if not installed and used in accordance with the instructions, may cause harmful interference to radio communications. However, there is no guarantee that interference will not occur in a particular installation. If this equipment does cause harmful interference to radio or television reception, which can be determined by turning the equipment off and on, the user is encouraged to try to correct the interference by one or more of the following measures:

- Reorient or relocate the receiving antenna.
- Increase the separation between the equipment and receiver.
- Connect the equipment into an outlet on a circuit different from that to which the receiver is connected.
- Consult the dealer or an experienced radio/TV technician for help.

GMRS Radio License

A valid individual license is required to operate a GMRS station. To obtain an individual license, an applicant must be eligible and follow the applicable rules and procedures established by FCC. The applicant must pay the required application and regulatory fees. Each individual license in the GMRS will normally have a term of ten years from the date of grant or renewal, and may be renewed pursuant to the procedures of FCC. To obtain a GMRS operator license, you need FCC Form 605 & 159, we suggest visiting the FCC website at <https://www.fcc.gov/wireless/support/fcc-form-605>, which includes necessary instructions. More questions about the license application, please contact the FCC at 1-888-225-5322 or go to the FCC's website: <http://www.fcc.gov>. According to FCC rules, any individual who holds an individual license may allow his or her immediate family members to operate his or her GMRS station or stations. Immediate family members are the licensee's spouse, children, grandchildren, stepchildren, parents, grandparents, stepparents, brothers, sisters, aunts, uncles, nieces, nephews, and in-laws.

•Disposal

The crossed-out wheeled-bin symbol on your product, literature, or packaging reminds you that all electrical and electronic products, batteries, and accumulators (rechargeable batteries) must be taken to designated collection locations at the end of their working life. Do not dispose of these products as unsorted municipal waste. Dispose of them according to the laws in your area.



Exposure Compliance and Control Guidelines

To control your exposure and ensure compliance with the occupational/controlled environment exposure limits, always adhere to the following procedures. When operating in front of the face, worn on the body, always place the radio in a Retevis approved clip, holder, holster, case, or body harness for this product. Using approved body-worn accessories is important because the use of Non-Retevis approved accessories may result in exposure levels, which exceed the IEEE/CNIRP RF exposure limits.

Transmit no more than the rated duty factor of 50% of the time. To Transmit (Talk), push the Push to Talk (PTT) button. To receive calls (listen), release the PTT button. Transmitting necessary information or less, is important because the radio generates measurable RF energy exposure only when transmitting in terms of measuring for standards compliance.

- DO NOT operate the radio without a proper antenna attached, as this may damage the radio and may also cause you to exceed RF exposure limits. A proper antenna is the antenna supplied with this radio by the manufacturer or an antenna specifically authorized by the manufacturer for use with this radio, and the gain shall not exceed the specified gain by the manufacturer declared.
- DO NOT transmit for more than 50% of total radio use time, more than 50% of the time can cause RF exposure compliance requirements to be exceeded.
- During transmissions, your radio generates RF energy that can possibly cause interference with other devices or systems. To avoid such interference, turn off the radio in areas where signs are posted to do so.
- DO NOT operate the transmitter in areas that are sensitive to electromagnetic radiation such as hospitals, aircraft, and blasting sites.
- Portable Device, this transmitter may operate with the antenna(s) documented in this filing in Push-to-Talk and body-worn configurations. RF exposure compliance is limited to the specific belt-clip and accessory configurations as documented in this filing and the separation distance between head and the device or its antenna shall be at least 2.5 cm.



Hand-held Mode

- Hold the radio in a vertical position with the microphone (and other parts of the radio including the antenna) at least 2.5 cm (one inch) away from the nose or lips. The antenna should be kept away from the eyes. Keeping the radio at a proper distance is important as RF exposure decreases with increasing distance from the antenna.



Avoid Choking Hazard



Small Parts. Not for children under 3 years.

Turn off your radio power in the following conditions:



- Turn off your radio before removing (installing) a battery or accessory or when charging battery.
- Turn off your radio when you are in a potentially hazardous environments: Near electrical blasting caps, in a blasting area, in explosive atmospheres (inflammable gas, dust particles, metallic powders, grain powders, etc.).
- Turn off your radio while taking on fuel or while parked at gasoline service stations.

NOTE: Nearly every electronic device is susceptible to electromagnetic interference (EMI) if inadequately shielded, designed, or otherwise configured for electromagnetic compatibility. To avoid electromagnetic interference and/or compatibility conflicts,

- Turn off your radio in any facility where posted notices instruct you to do so, hospitals or health care facilities (Pacemakers, Hearing Aids and Other Medical Devices) may be using equipment that is sensitive to external RF energy.
- Turn off your radio when on board an aircraft. Any use of a radio must be in accordance with applicable regulations per airline crew instructions.

Protect your hearing:



- Use the lowest volume necessary to do your job.
- Turn up the volume only if you are in noisy surroundings.
- Turn down the volume before adding headset or earpiece.
- Limit the amount of time you use headsets or earpieces at high volume.
- When using the radio without a headset or earpiece, do not place the radio's speaker directly against your ear
- Use careful with the earphone maybe possible excessive sound pressure from earphones and headphones can cause hearing loss



Note: Exposure to loud noises from any source for extended periods of time may temporarily or permanently affect your hearing. The louder the radio's volume, the less time is required before your hearing could be affected. Hearing damage from loud noise is sometimes undetectable at first and can have a cumulative effect.

Avoid Burns



Antennas

•Do not use any portable radio that has a damaged antenna. If a damaged antenna comes into contact with the skin when the radio is in use, a minor burn can result.

Batteries

- When the conductive material such as jewelry, keys or chains touch exposed terminals of the batteries, may complete an electrical circuit (short circuit the battery) and become hot to cause bodily injury such as burns. Exercise care in handling any battery, particularly when placing it inside a pocket, purse or other container with metal objects
- KEEP BATTERY OUT OF REACH OF CHILDREN
- Store spare batteries securely
- If the battery compartment (if applicable) does not close securely, stop using the product and keep it away from children
- If you think batteries might have been swallowed or placed inside any part of the body, seek immediate medical attention
- Dispose of used batteries immediately and safely

Long transmission

•When the transceiver is used for long transmissions, the radiator and chassis will become hot.

Safety Operation



Forbid

- Do not use charger outdoors or in moist environments, use only in dry locations/conditions.
- Do not disassemble the charger, that may result in risk of electrical shock or fire.
- Do not operate the charger if it has been broken or damaged in any way.
- Do not place a portable radio in the area over an air bag or in the air bag deployment area. The radio may be propelled with great force and cause serious injury to occupants of the vehicle when the air bag inflates.

To reduce risk

- Pull by the plug rather than the cord when disconnecting the charger.
- Unplug the charger from the AC outlet before attempting any maintenance or cleaning.
- Contact Retevis for assistance regarding repairs and service.

- The adapter shall be installed near the equipment and shall be easily accessible

Approved Accessories



WARNING

- This radio meets the RF exposure guidelines when used with the Retevis accessories supplied or designated for the product. Use of other accessories may not ensure compliance with the RF exposure guidelines and may violate regulations.
- For a list of Retevis-approved accessories for your radio model, visit the following website:
<http://www.Retevis.com>

Guarantee

Model Number: _____

Serial Number: _____

Purchasing Date: _____

Dealer: _____ Telephone: _____

User's Name: _____ Telephone: _____

Country: _____ Address: _____

Post Code: _____ Email: _____

Remarks:

- 1.This guarantee card should be kept by the user, no replacement if lost.
2. Most new products carry a two-year manufacturer's warranty from the date of purchase.
3. The user can get warranty and after-sales service as below:
 - Contact the seller where you buy.
 - Products Repaired by Our Local Repair Center
4. For warranty service, you will need to provide a receipt proof of purchase from the actual seller for verification

Exclusions from Warranty Coverage:

1. To any product damaged by accident.
2. In the event of misuse or abuse of the product or as a result of unauthorized alterations or repairs.
3. If the serial number has been altered, defaced, or removed.

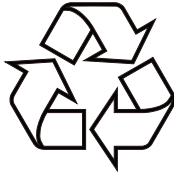

CE FCC RoHS



Shenzhen Retevis Technology Co.,Ltd.

7/F, 13-C, Zhonghaixin Science&Technology Park, No.12 Ganli
6th Road, Jihua Street, Longgang District, Shenzhen, China

Web:www.ailunce.com

E-mail:hams@ailunce.com

Facebook:[@ailunce](https://www.facebook.com/ailunce)



MADE IN CHINA

说明书要求

尺寸：120*160mm

印刷：黑白印刷

装订：骑马钉

纸张材质：双胶纸

本页无需印刷

2024/6/3-品牌logo、认证标志、公司网址、二维码更新